

2N3906

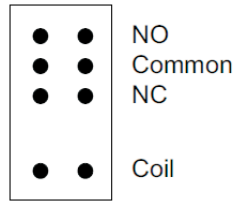

Rayex LM2-12D Relay

5 Pin DIN Female Connector

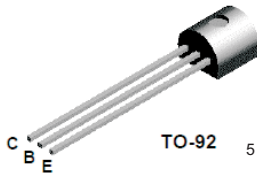
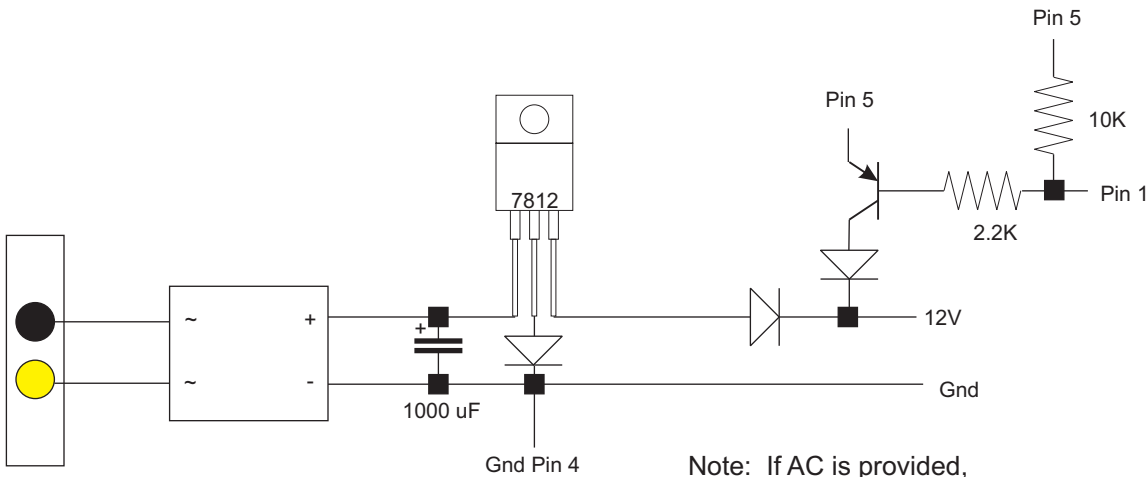
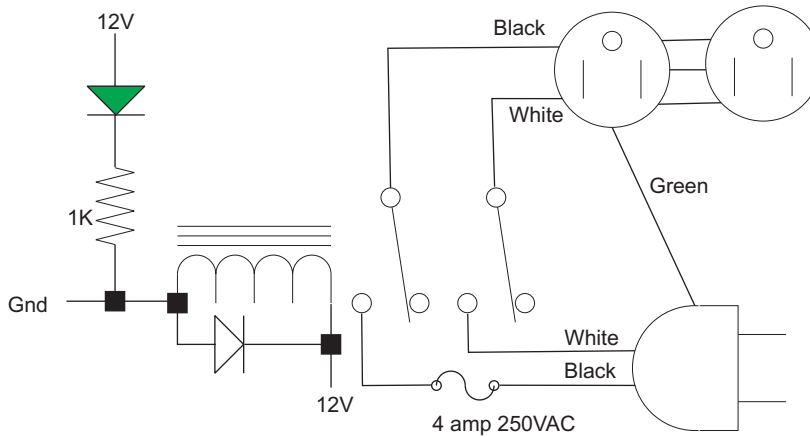
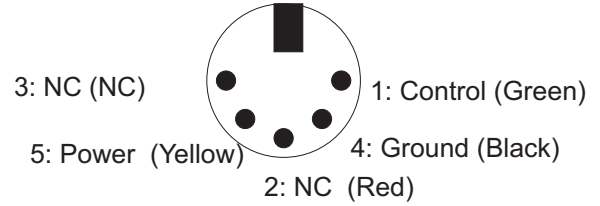

Note: If AC is provided, then it will take priority over the 5 pin DIN input

120 VAC Control  
Norbert Doerry  
August 26, 2011

<b>Maximum 400 Watts</b>	<b>12 to 24 VAC</b>	<b>Maximum 4 amp Fuse</b>
--------------------------	---------------------	---------------------------

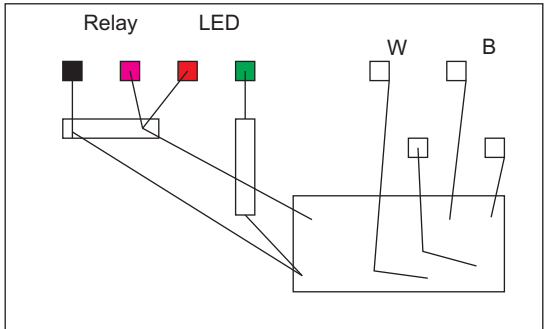
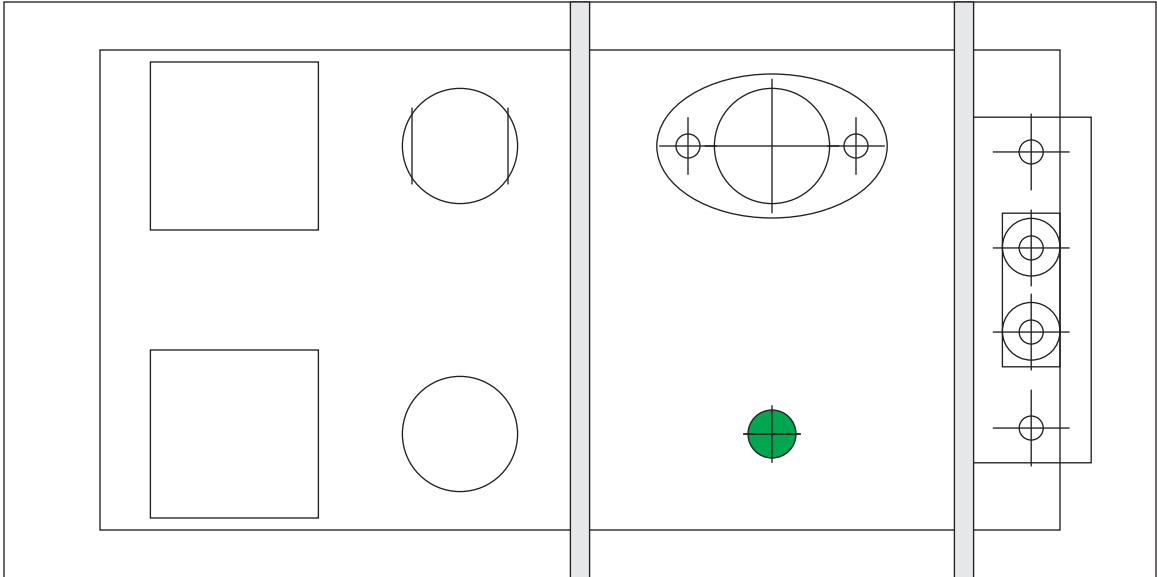

Outlet

Cord

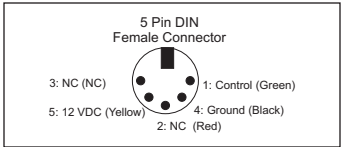

**120 VAC Controlled Switch**  
August 28, 2011

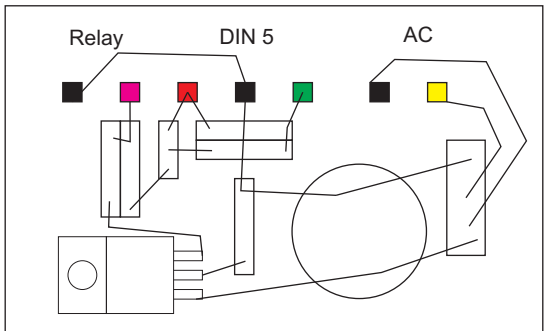

**120 VAC Control**  
**Norbert Doerry**  
**August 28, 2011**