

Electric Load Modeling

Dr. Norbert Doerry and Dr. John Amy Jr

U.S. Navy

ASNE Intelligent Ships Symposium

Philadelphia PA

April 9-10, 2019

Motivation

- Traditional Electric Power Load Analysis (EPLA) no longer sufficient for Power Electronics based powers distribution systems.
 - Different levels of aggregation
 - Different thermal time constants
 - Different impacts of overloads
- Also need to address new concerns
 - Common mode behavior
 - Impact of controls



Courtesy L3T



U.S. Navy photo by Mass Communication Specialist 3rd Class Robert S. Price

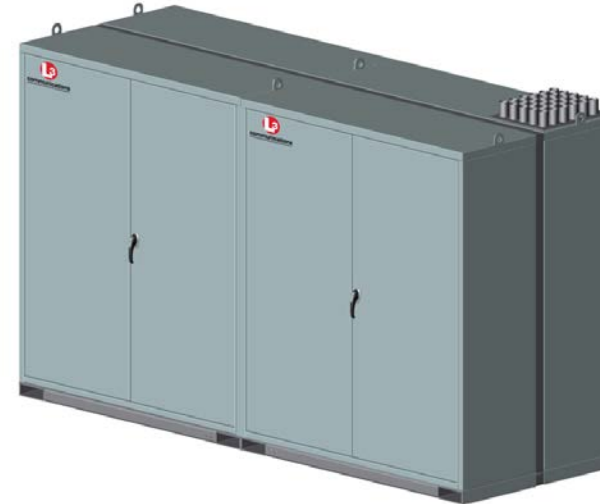

<https://www.l-3mps.com/powerparagon/pdfs/MVMD%202011.pdf>



<https://www.l-3mps.com/powerparagon/pdfs/Bulletin%20310%20-09.pdf>

T9070-A3-DPC-010/310-1 (AKA DPC 310-1)

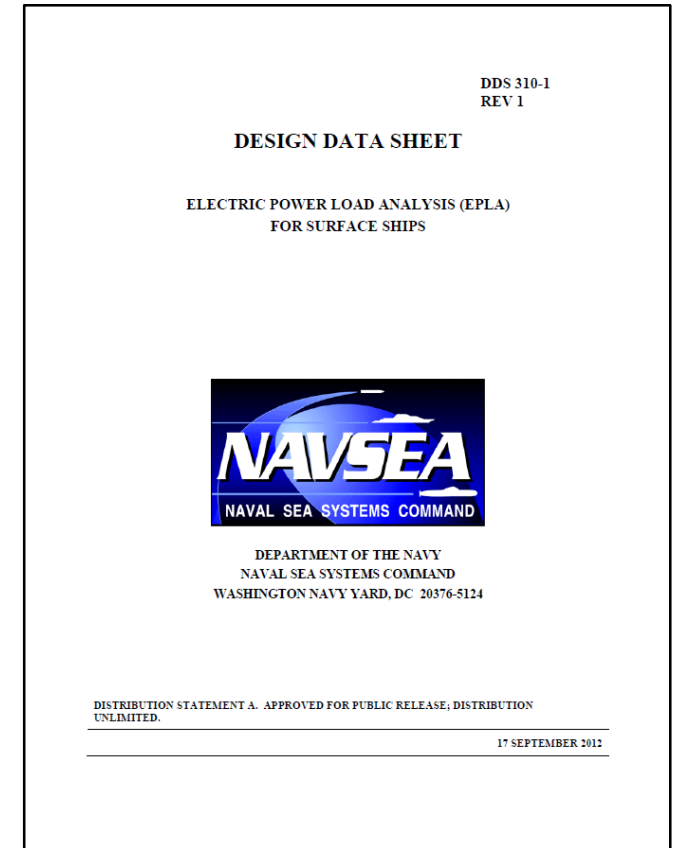
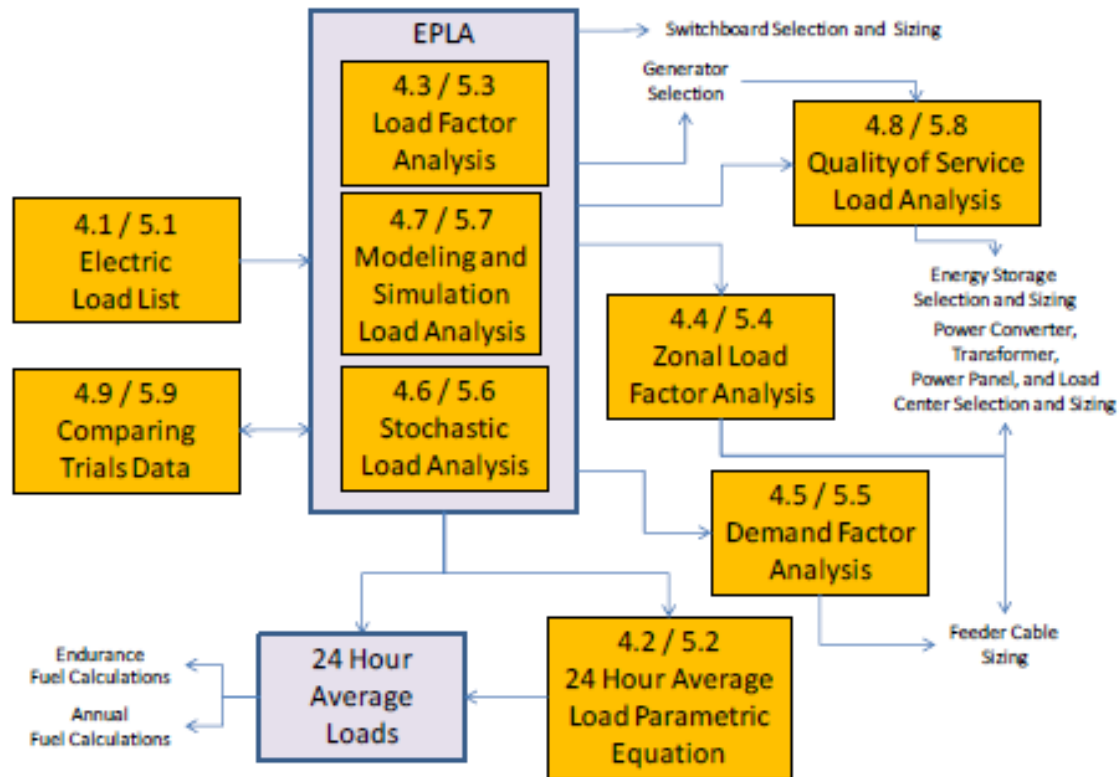

Time Scale is Important

- Seconds (MIL-E-7016F suggests 5 seconds)
 - Thermal limit for power electronics
- Minutes (MIL-E-7016F suggests 5 minutes)
 - Thermal limit for copper – steel based equipment
- 24 hours
 - Annual Fuel Consumption



Cycling Load Profile

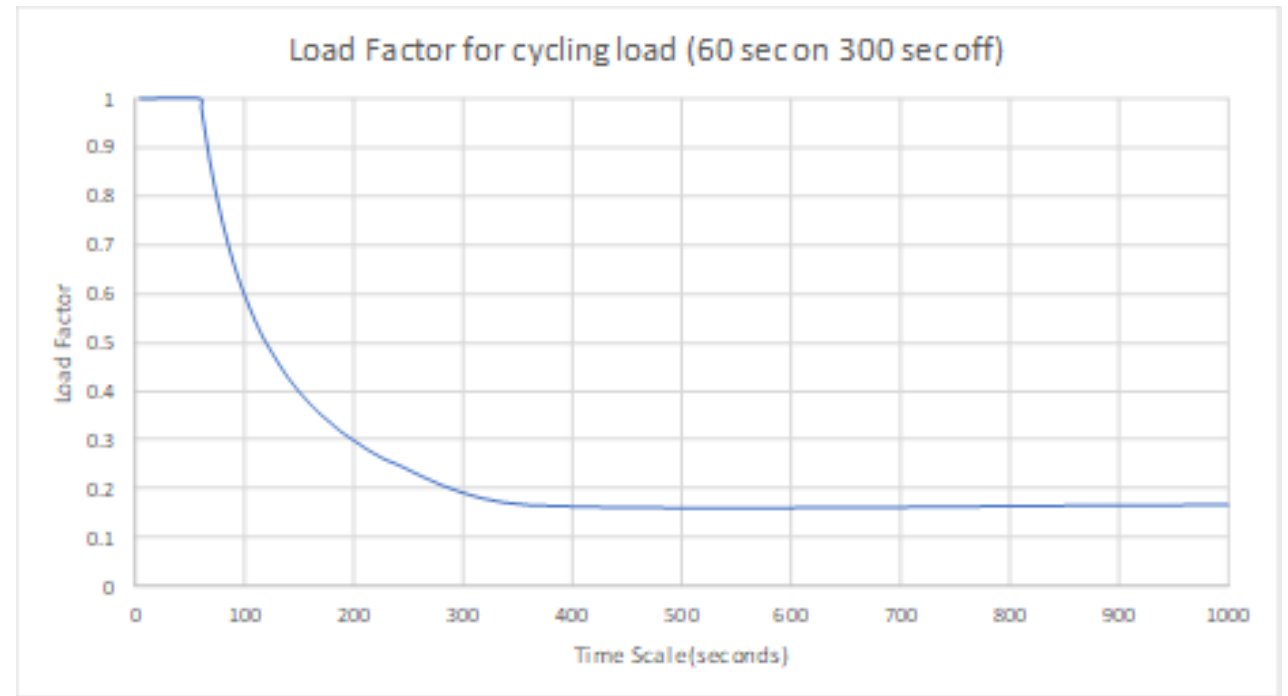
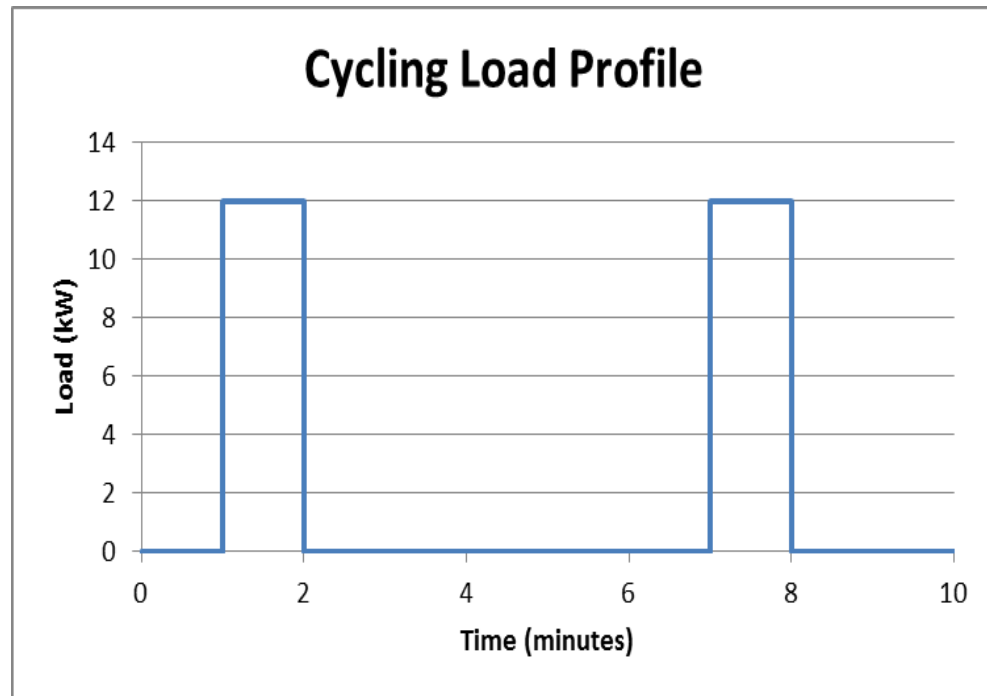

Impact on Voltage due to overload

- Resistive Load with current limiting source
 - Probability of overload which results in voltage being out of limits should be very low
- Constant Power loads are a concern
 - If sum of constant power loads is greater than supply, then voltage collapse
 - Need to ensure with very high probability that constant power loads will not exceed the source rating

$$\frac{V}{V_n} = \frac{P_{rated}}{P_{demand}}$$

Source Rating

Nominal System Voltage

Overload

$$\frac{V}{V_n} = \frac{P_{rated} - P_{CPL}}{P_{demand} - P_{CPL}}$$

Levels of Aggregation

- The fewer the loads in an aggregation the greater attention need be placed on variance
- Zonal load factor analysis adjusts for this variability
- Stochastic methods or modeling and simulation methods may be more appropriate

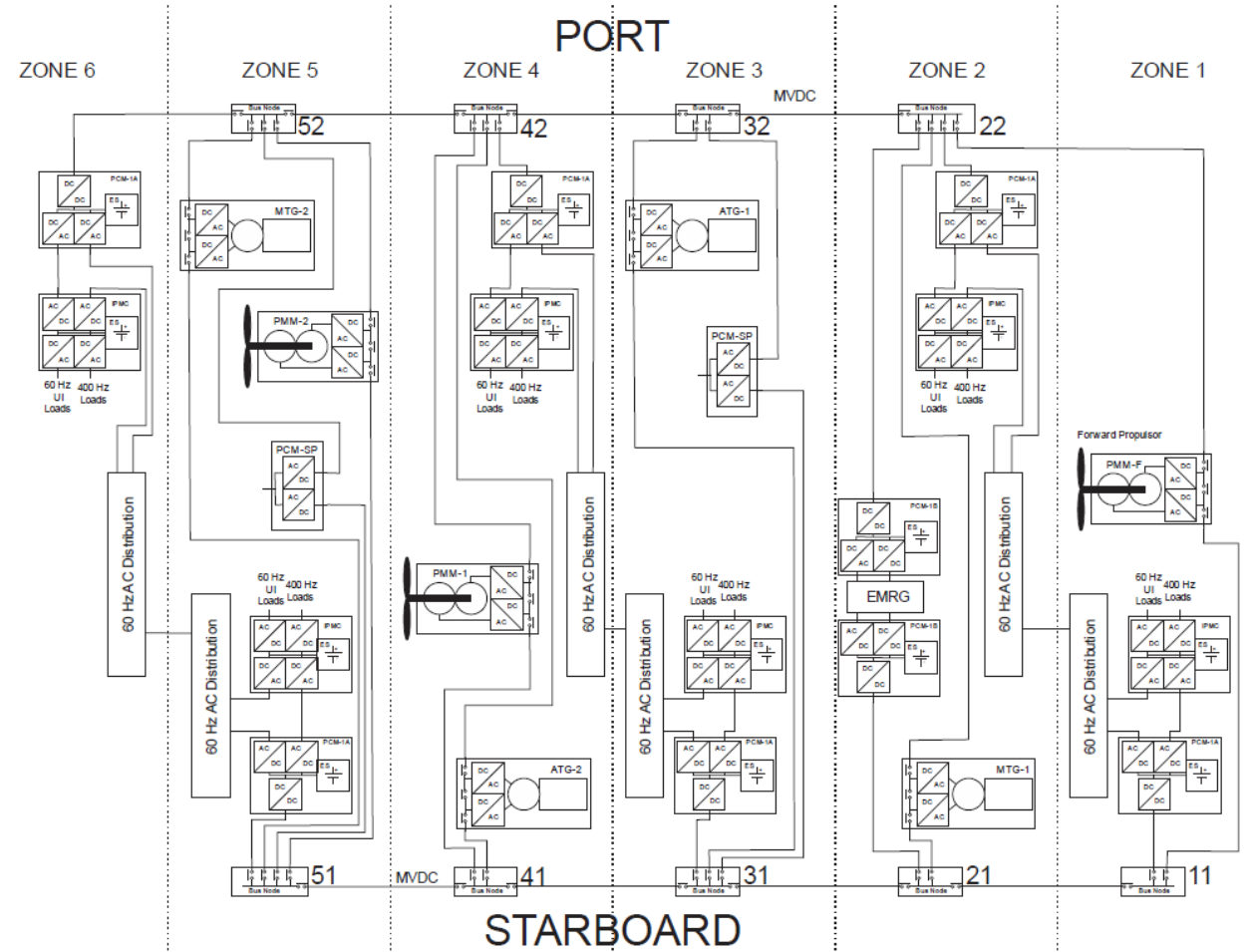

Stochastic Models

- Pure Stochastic
 - Probability Density Function (PDF) for the load profile
 - Hard to adjust for different conditions
- Time Scale Stochastic
 - Create PDF of average values over time scale of interest.
 - Can take advantage of overload capability of source
- Time Domain Stochastic
 - Model profile as a function of random variables
 - “On” Time
 - “Off” Time
 - Load when “on”
 - Load when “off”
 - Easier to adjust for different conditions
 - Can use Markov Chains for multiple states

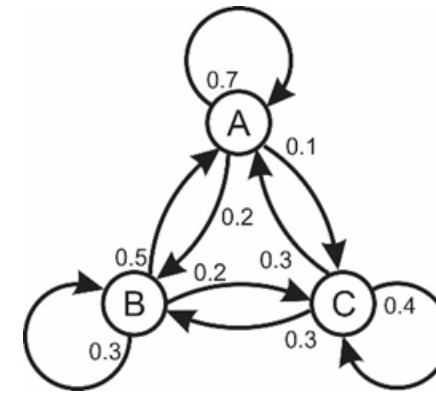
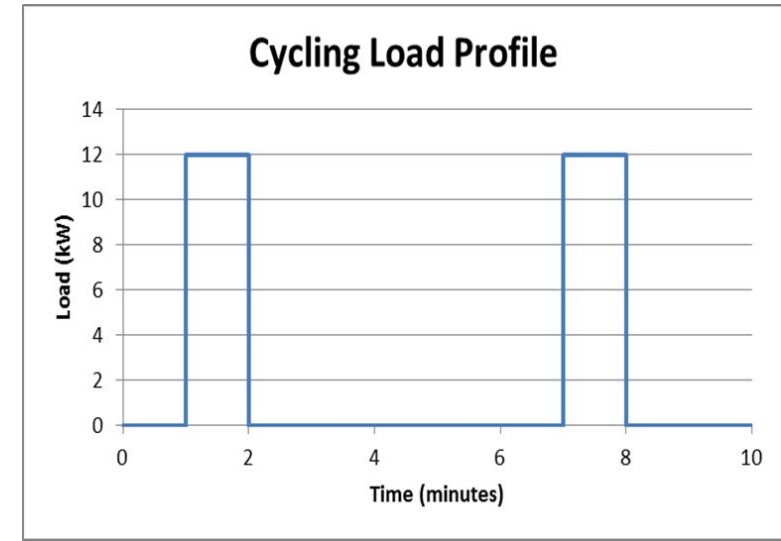

$$P = \begin{bmatrix} 0.7 & 0.5 & 0.3 \\ 0.2 & 0.3 & 0.3 \\ 0.1 & 0.2 & 0.4 \end{bmatrix}$$

Other Challenges

- Common Mode Currents
- Unintended Circuit
- Controls
- Stability
- Quality of Service

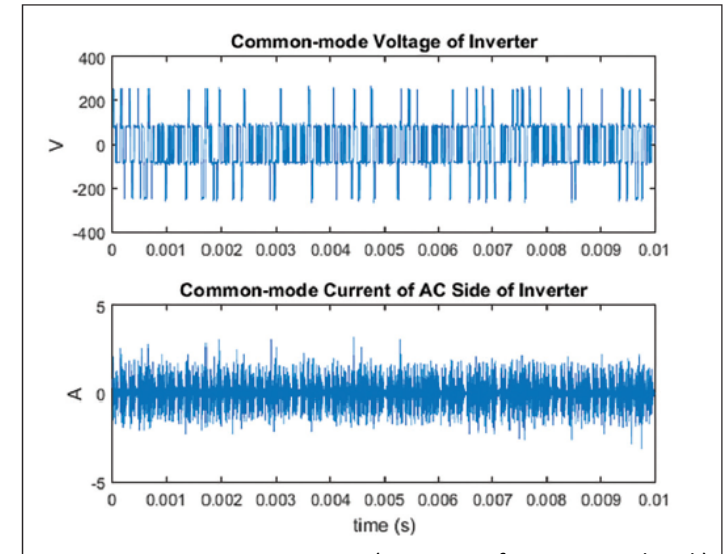
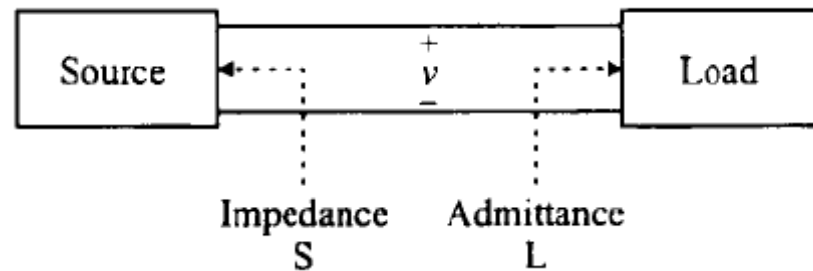

(Courtesy of Dr. Steve Pekarek)

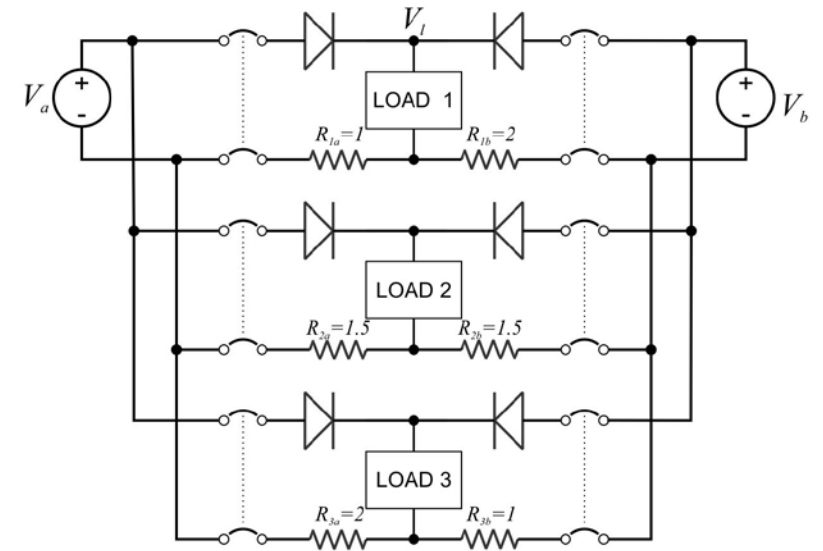

Observations and Conclusions

- A good EPLA is more than a load list with load factors blindly taken from DPC 310-1.
- The modeling effort must reflect the time scales of interest and the impact of overloads.
- For any given aggregation of loads, choose the modeling effort that requires the least effort but provides satisfactory results.
- Higher fidelity modeling may result in a less costly system.



(U.S. Navy photo courtesy of Bath Iron Works)