

# RASPBERRY PI BASIC INTERFACES

Norbert Doerry

November 2018

rev A: Dec 2018

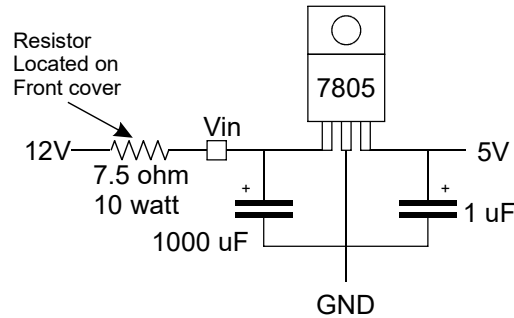
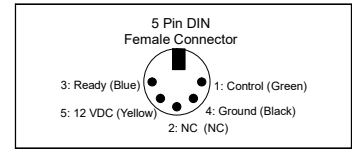

## Power Supply

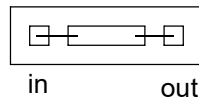
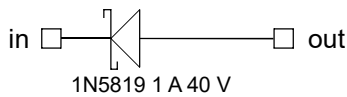

## INPUT BUFFER

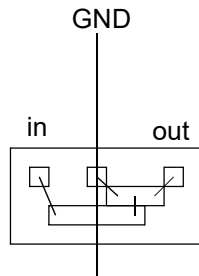
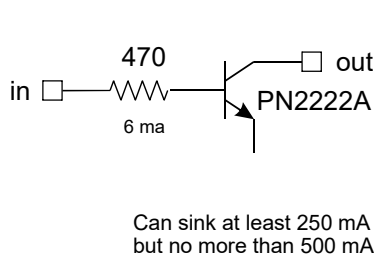

## OUTPUT BUFFER

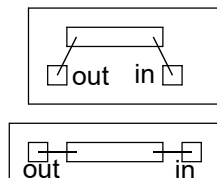
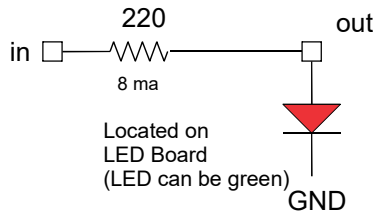

## LED BUFFER

## Power On LED

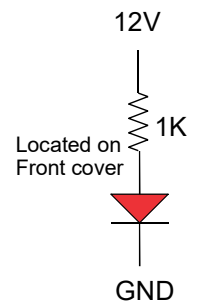

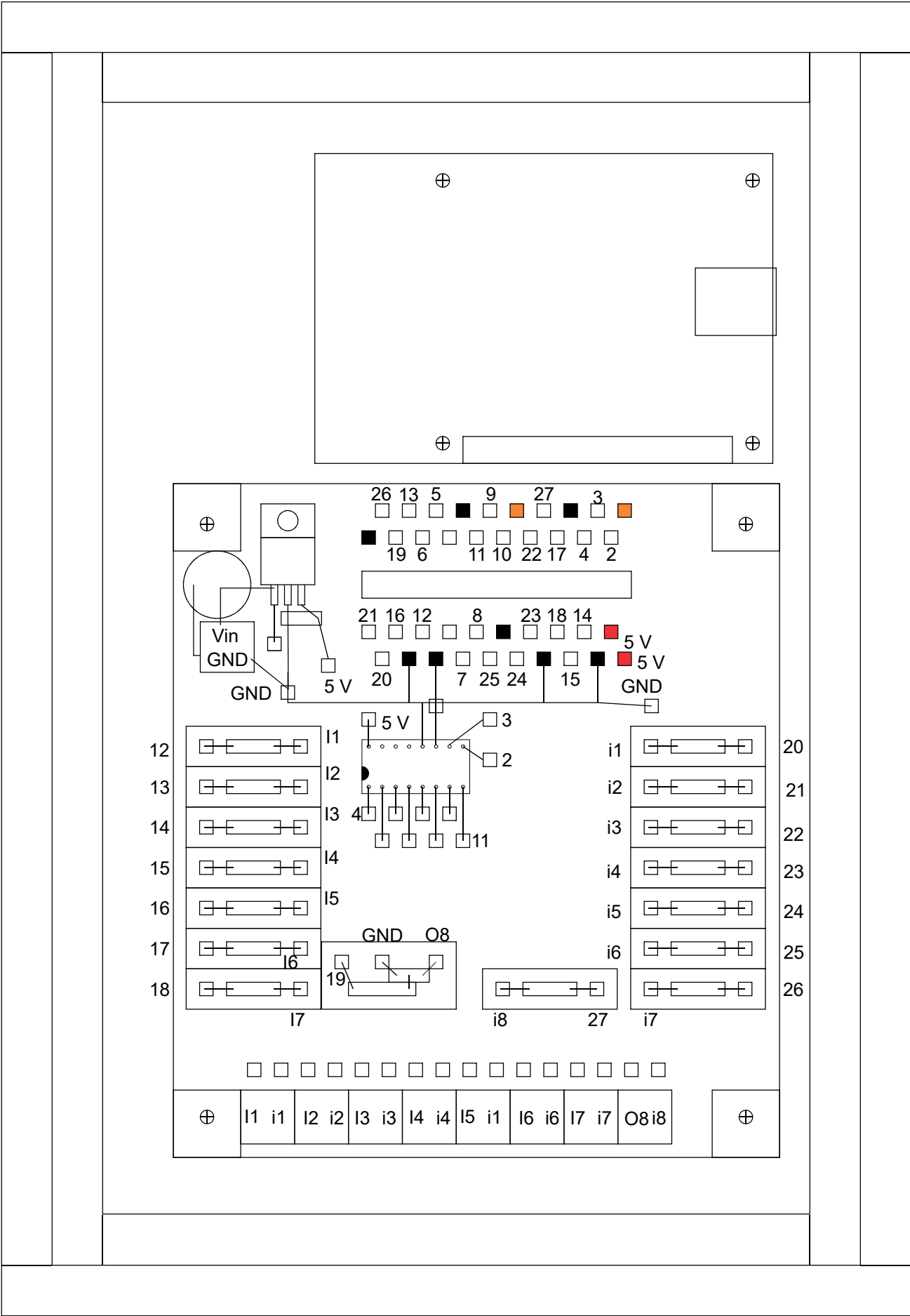

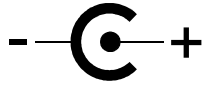
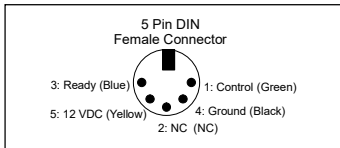

Ethernet

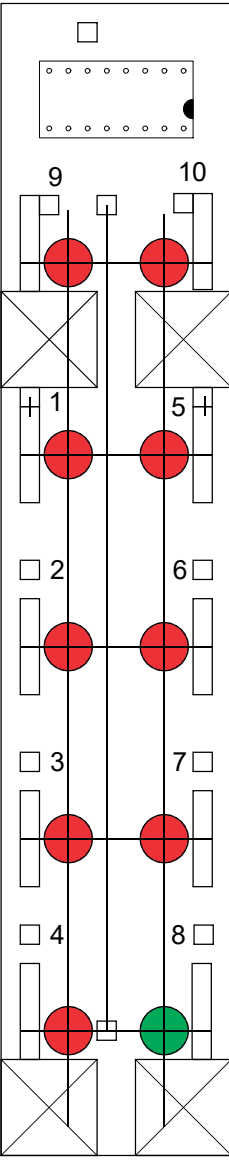
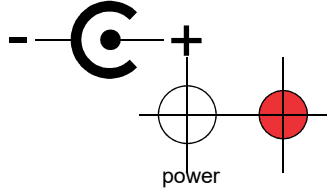
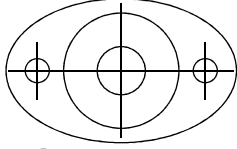

connector on back side

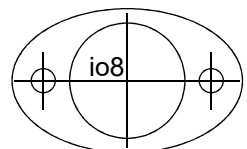
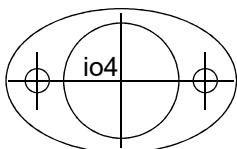
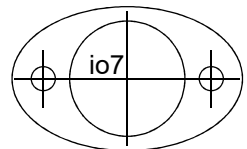
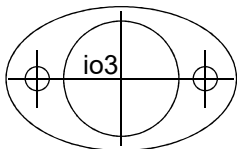
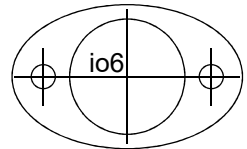
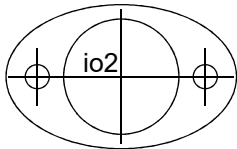
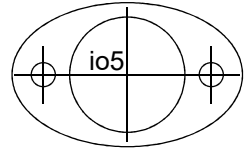
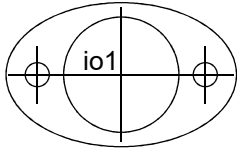

ALARM

